

ORIGINAL RESEARCH

Ventilatory oscillations at exercise: effects of hyperoxia, hypercapnia, and acetazolamide

Eric Hermand¹, François J. Lhuissier^{1,2}, Julie Larribaut¹, Aurélien Pichon¹ & Jean-Paul Richalet^{1,2}¹ Université Paris 13, Sorbonne Paris Cité, Laboratoire "Hypoxie et poumon", Bobigny, France² Assistance Publique-Hôpitaux de Paris, Hôpital Avicenne, Service de Physiologie, explorations fonctionnelles et médecine du sport, Bobigny, France**Keywords**

Acetazolamide, exercise, hypercapnia, hyperoxia, hypoxia, periodic breathing, ventilatory oscillations.

CorrespondenceEric Hermand, Laboratoire "Hypoxie et poumon", EA2363, 74 rue Marcel Cachin, 93017 Bobigny Cedex, France.
Tel: 33148387758
Fax: 33148388924
E-mail: eric.hermand17@gmail.com**Funding Information**

This study was supported by Legs POIX grants from the Chancellerie des Universités de Paris (B380).

Received: 28 May 2015; Accepted: 2 June 2015

doi: 10.14814/phy2.12446

Physiol Rep, 3 (6), 2015, e12446,
doi: 10.14814/phy2.12446

Clinical Trial reg. n°: NCT02201875.

Abstract

Periodic breathing has been found in patients with heart failure and sleep apneas, and in healthy subjects in hypoxia, during sleep and wakefulness, at rest and, recently, at exercise. To unravel the cardiorespiratory parameters liable to modulate the amplitude and period of ventilatory oscillations, 26 healthy subjects were tested under physiological (exercise) and environmental (hypoxia, hyperoxia, hyperoxic hypercapnia) stresses, and under acetazolamide (ACZ) treatment. A fast Fourier transform spectral analysis of breath-by-breath ventilation (\dot{V}_E) evidenced an increase in \dot{V}_E peak power under hypercapnia (vs. normoxia and hyperoxia, $P < 0.001$) and a decrease under ACZ (vs. placebo, $P < 0.001$), whereas it was not modified in hyperoxia. \dot{V}_E period was shortened by exercise in all conditions (vs. rest, $P < 0.01$) and by hypercapnia (vs. normoxia, $P < 0.05$) but remained unchanged under ACZ (vs. placebo). \dot{V}_E peak power was positively related to cardiac output (\dot{Q}_c) and \dot{V}_E in hyperoxia ($P < 0.01$), in hypercapnia ($P < 0.001$) and under ACZ ($P < 0.001$). \dot{V}_E period was negatively related to \dot{Q}_c and \dot{V}_E in hyperoxia ($P < 0.01$ and $P < 0.001$, respectively), in hypercapnia ($P < 0.05$ and $P < 0.01$, respectively) and under ACZ ($P < 0.05$ and $P < 0.01$, respectively). Total respiratory cycle time was the main factor responsible for changes in \dot{V}_E period. In conclusion, exercise, hypoxia, and hypercapnia increase ventilatory oscillations by increasing \dot{Q}_c and \dot{V}_E , whereas ACZ decreases ventilatory instability in part by a contrasting action on O_2 and CO_2 sensing. An intrinsic oscillator might modulate ventilation through a complex system where peripheral chemoreflex would play a key role.

Introduction

In most usual circumstances, human ventilation adapts to the demand of the organism around a steady-state value. However, its control is known to be challenged under various specific conditions. For example, patients suffering from chronic heart failure (CHF) or apnea syndrome (central, obstructive, or mixed) show breathing pattern marked by large oscillations with a period of around 1 min at rest, awake or asleep, and during exercise. Oscillations are also present in healthy subjects at high altitude during sleep

(Berssenbrugge et al. 1983; Ainslie et al. 2013), in wakeful state (Waggener et al. 1984; Fan et al. 2012) and in patients suffering from chronic mountain sickness (Richalet et al. 2005). Several factors are involved in breathing instability. Reduced blood flow and exacerbated chemosensitivity are common in CHF at rest (Pinna et al. 2000) and during exercise (Agostoni 2008; Dhakal et al. 2012). Obstructive sleep apneas (OSA) are associated with anatomical factors inducing airway obstruction and decreased central respiratory drive to genioglossus muscle during sleep (Dempsey et al. 2010). These factors may disturb the respiratory

control loop and impair the ability of the system to effectively control ventilation.

In awake subjects, only one observation of ventilatory oscillations during exercise has been reported at high altitude (Garde et al. 2012). We recently described this phenomenon, with a period of around 11 sec, in subjects exercising in mild hypoxia (Hermand et al. 2015). The analysis of cardiorespiratory parameters has highlighted some factors that may have an impact on the period and amplitude of ventilatory oscillations: unlike CHF patients whose severity of periodic breathing is related to reduced cardiac output, the amplitude of oscillations in healthy subjects was positively correlated with cardiac output and ventilation during exercise in hypoxia, whereas their period was shorter during exercise as compared to rest (Hermand et al. 2015).

Peripheral and central chemoreceptors, respectively, inform respiratory centers about O_2 and CO_2 status. The response to hypoxia is mainly due to peripheral chemoreceptors (Lahiri et al. 2006; Kumar and Prabhakar 2012), whereas the level of arterial or interstitial partial pressure of CO_2 (P_{CO_2}) is detected by central chemoreceptors, with gain adjustments from peripheral chemoreceptors (Lahiri and Forster 2003; Blain et al. 2010), although these interactions have been debated in humans (Duffin and Mateika 2013). We suggested that peripheral chemoreceptors play an important role in the genesis of ventilatory oscillations, more pronounced in subjects with a higher hypoxic ventilatory response, thus revealing the unstable nature of the ventilatory control system under physiological and environmental stresses. The degree of ventilatory instability is linked to the loop gain, which is the product of the controller gain, that is, the ventilatory response to hypoxia and/or hypercapnia, and the plant gain, that is, the effect of a ventilation variation on arterial P_{CO_2} (P_{aCO_2}) and/or arterial P_{O_2} (P_{aO_2}). The higher the gain, the more unstable the system (Cherniack 2005; Burgess 2012). Therefore, as in CHF, a greater sensitivity of central and peripheral respiratory drive to CO_2 and O_2 , through greater hypoxic and hypercapnic ventilatory responses (Solin et al. 2000; Giannoni et al. 2009; Maestri et al. 2013) would lead to more pronounced oscillations of ventilation (Francis et al. 2000; Basner 2011).

Various interventions are available to modulate this breathing instability. Occasional CO_2 inhalation during sleep considerably diminishes apnea occurrences in Cheynes-Stokes respiration (CSR) by keeping CO_2 arterial pressure above apneic threshold (Andreas et al. 1998; Lorenzi-Filho et al. 1999). Hyperoxia has more conflicting effects: it reduces the hypoxemia involved in the mechanisms of periodic breathing, and therefore improves heart condition, physical performance, and

apnea/hypopnea index in CSR patients (Andreas et al. 1996; Franklin et al. 1997), but does not abolish ventilatory oscillations in OSA (Gold et al. 1985) and CHF patients (Ponikowski et al. 1999). Conversely, at high altitude, O_2 therapy significantly reduces sleep apneas and periodic breathing, and improves sleep quality in normal subjects (McElroy et al. 2000; Moraga et al. 2014).

Pharmacological interventions are also available for breathing disorders. Carbonic anhydrase inhibitors are proven to be effective treatment for acute (Swenson et al. 1991) and chronic (Richalet et al. 2005) mountain sickness, as well as for ventilatory disorders in healthy subjects at high altitude (Swenson et al. 1991; Fischer et al. 2004; Ainslie et al. 2013). They are also experimentally used to treat periodic breathing in CSR, CHF, and OSA patients (Edwards et al. 2012; Apostolo et al. 2014; Javaheri et al. 2014). Their complex action is still to be fully understood, and involves several contradictory mechanisms, associating central stimulation, and reduction in peripheral chemoreceptors activity (Swenson 1998; Teppema 2014). Through a greater stimulation of central chemoreceptors by CO_2 , acetazolamide (ACZ) elevates ventilation level and O_2 saturation in patients suffering from apneas and in healthy subjects at high altitude, and considerably reduces occurrence and length of apnea episodes. ACZ also increases ventilatory response to CO_2 in patients with chronic mountain sickness (Rivera-Ch et al. 2008). A similar effect on ventilatory oscillations was observed in awake CHF patients at rest and during exercise (Fontana et al. 2011; Apostolo et al. 2014). Similarly, the role of ACZ-induced changes in controller gain and plant gain are still debated (Burgess 2012; Edwards et al. 2012).

Until now, the phenomenon of ventilatory oscillations was well described mostly in patients and in sojourners at high altitude during sleep. Recently, a similar pattern was unveiled in normal subjects during exercise in hypoxia (Hermand et al. 2015). Since the period of oscillations observed in this preliminary study is much shorter than in patients, and as the intensity of oscillations is associated with high cardiac output (exercise) contrary to pathological conditions (CHF, CSR), this strongly suggests that the involved mechanisms are different. Therefore, the objective of this study is to unravel the mechanisms by which the ventilatory control system becomes unstable and generates oscillations in awake subjects at exercise.

In order to assess the respective role of central and peripheral chemoreceptors, respectively, sensitive to variations of CO_2 and O_2 , we propose to submit our model of ventilatory oscillations in healthy subjects to various external constraints such as hyperoxia, hypercapnia and pharmacological treatment by ACZ.

Subjects and Methods

Subjects

Twenty-six healthy and nonsmoking male subjects volunteered for the study and were given complete information about the successive tests. All were in good physical condition, with a medium to high level of regular physical activity (from 2 to 10 h per week). They showed no evidence of cardiovascular or pulmonary disease. Subjects' characteristics are presented in Table 1. The protocol was approved by the Ile-de-France Ethics Committee (CPP-IDF2) and an individual written informed consent has been collected from all subjects. The study was registered as Clinical Trial reg. n°: NCT02201875.

Procedure

All subjects were first asked to perform a standard ramp test protocol on a cycloergometer to determine their maximal aerobic power (MAP, Table 1): after a 3-min warm-up at 60 watts, power output was increased by 30-watt steps every 2 min until exhaustion.

For all studies, minute ventilation ($\dot{V}E$, L·min⁻¹) was measured through a metabograph (Vmax Encore; Sensor-Medics, Yorba Linda, CA). Tidal volume (VT, L), total respiratory cycle time (Ttot, sec), and inspiratory time (Ti, sec) were derived from the ventilation signal. Pulse O₂ saturation (SpO₂, %) was measured by transcutaneous oximetry (Nellcor N-595; Nellcor, Pleasanton, CA) on a prewarmed ear lobe. End tidal PCO₂ (PETCO₂, mmHg) was measured by infrared thermopile (Vmax Encore, SensorMedics). During the whole test, $\dot{V}E$, SpO₂ and PETCO₂ were recorded breath-by-breath (Fig. 1). Data were transferred to a computer for further variability analysis. A Fast Fourier Transform (FFT) was then applied to the breath-by-breath ventilation signal, extracted from the raw data, in sequences of 128 points (one point per second) of a steady-state interval at the end of each phase of the test. This method allowed us to detect the presence of peaks in the frequency domain of the ventilation signal (Fig. 2) (Hermand et al. 2015). Two main parameters were derived from the FFT: the frequency in hertz (or period in seconds) of the larger peak and its power estimated as the area under the peak at ± 0.02 Hz around the peak (in L²·min⁻², %² and mm·Hg², respec-

tively, for $\dot{V}E$, SpO₂, and PETCO₂ spectra). Thus, a high peak power translates into greater ventilatory oscillations. This method allowed us to precisely quantify the presence of oscillations in the signals that are not observable in the standard protocol routinely used in the hypoxic exercise test where the signals are averaged every 20 sec (Lhuissier et al. 2012; Richalet et al. 2012; Bourdillon et al. 2014; Canoui-Poitaine et al. 2014). Cardiac output ($\dot{Q}c$, L·min⁻¹) was measured using a noninvasive impedance cardiograph device (PhysioFlow PF-05; Manatec Biomedical, Paris, France) (Charloux et al. 2000; Richard et al. 2001).

The ventilatory response to CO₂ (HCVR) was determined using a modified Read's rebreathing method (Read 1967). After breathing room air through a mouthpiece device to establish a baseline, the valve was switched to a 10-L rebreathing bag containing a mixture of 93% O₂ and 7% CO₂. After two deep breaths in order to speed up the gas mixing in the lungs, the subject was asked to spontaneously breathe in the bag until ventilation reached 60 L·min⁻¹. Collected data were then compiled in a $\dot{V}E$ -PETCO₂ graph to calculate HCVR from the slope of the linear regression between $\dot{V}E$ and PETCO₂ (see inlets in Fig. 1). HCVR was measured once in each subject for the hyperoxia and hypercapnic hyperoxia studies and twice (under placebo and ACZ) in the ACZ study.

Hyperoxia and hypercapnic hyperoxia studies

Four tests were randomly conducted, in normoxia and hyperoxia (O₂ 100%), then, at least 1 week apart, in normoxia and hypercapnic hyperoxia (O₂ 93%, CO₂ 7%) in 13 subjects. After 1 min rest for material habituation and cardiorespiratory parameters stabilization, subjects were first asked to keep a resting sitting position on the ergometer for 6 min, and then to pedal for 6 min at around 65 rpm pedaling cadence at an exercise intensity of 30% of MAP.

ACZ study

In a double-blind, placebo-controlled, cross-over study, 13 subjects were asked to take either a placebo or a 250 mg ACZ pill, on morning breakfast and at midday lunch, on the day before and on tests days. Tests were performed in the afternoon following the last intake. One

Table 1. Characteristics of the subjects of the hyperoxia/hypercapnic hyperoxia and acetazolamide (ACZ) studies.

	<i>n</i>	Age (years)	Body weight (kg)	Height (cm)	Maximal Aerobic Power (W)
Hyperoxia/Hypercapnic hyperoxia	13	30.0 ± 9.3	73.7 ± 9.0	174.7 ± 7.8	272.7 ± 44.2
ACZ	13	24.3 ± 3.8	71.8 ± 5.6	174.8 ± 5.6	233.3 ± 38.5

Mean ± SD. No significant difference between groups.

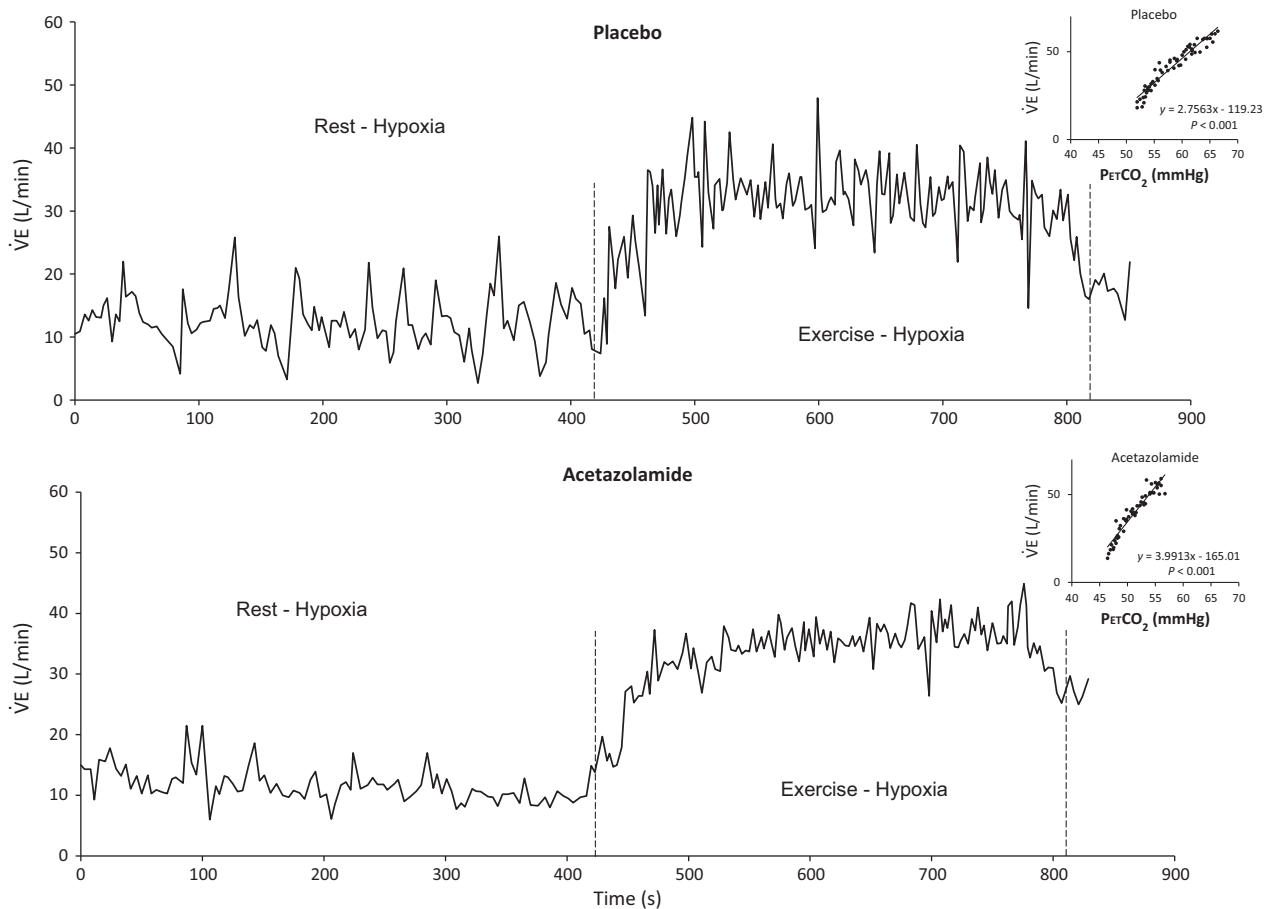

Figure 1. Breath-by-breath ventilation recordings in subject n° 4, under placebo (upper panel) and acetazolamide (lower panel) treatment. Inlets: ventilatory response to CO₂ (upper right: placebo, lower right: acetazolamide).

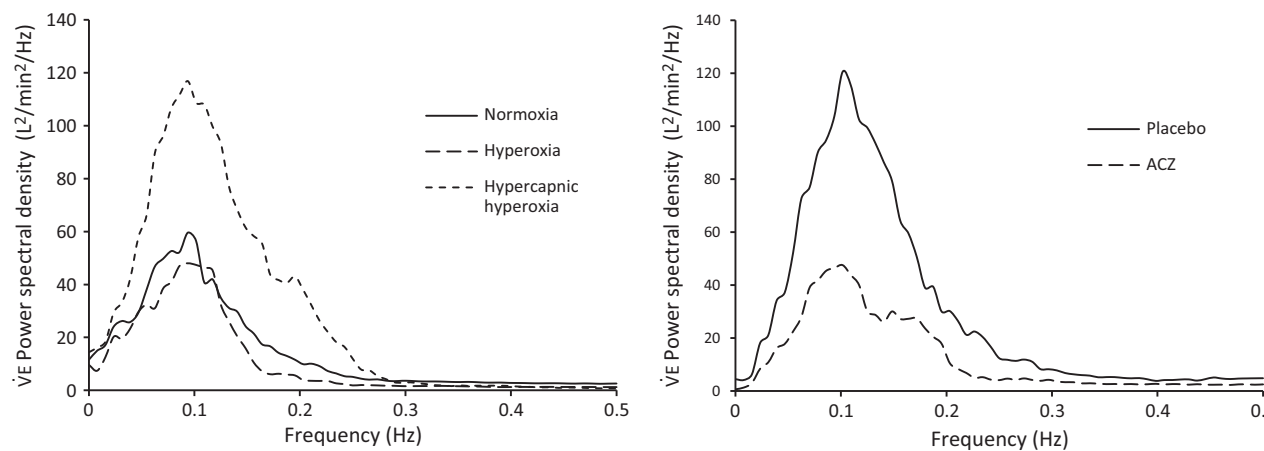

Figure 2. Power spectral density of the ventilation signal at exercise. Left panel: normoxia, hyperoxia, and hypercapnic hyperoxia (subject n°4). Right panel: placebo and ACZ (subject n°4) in hypoxia.

week at least separated the two testing days. Under each condition, subjects underwent two randomized tests: one in normoxia and one in hypoxia (normobaric simulated

altitude of 3000 m). As in the hypercapnic hyperoxia studies, a 6-min rest/6-min exercise test was performed and exercise intensity was set at 30% of MAP.

Statistical analysis

Results are presented as mean ± standard deviation. Regarding the expected difference in mean period (3 sec), the standard deviation (2.4 sec), a level of significance at 0.05% and a statistical power at 80%, the minimum number of subjects to be included was 7 for each protocol. As spectra peak power showed a high standard deviation and a non-normal distribution, we performed a logarithmic transformation of raw data, and calculated a minimum number of subjects of 10 to include. Normality of data on each condition (rest/exercise, normoxia/hypoxia/hyperoxia/hypercapnia, placebo/ACZ) were verified by a Shapiro–Wilk normality test. In the hyperoxia and hypercapnic hyperoxia studies, two-way analyses of variance (ANOVA) with repeated measures were done (rest/exercise, normoxia/hyperoxia or normoxia/hypercapnic hyperoxia). The same subjects participated in both hyperoxic and hypercapnic hyperoxic studies. Therefore, we performed a two-way analysis of variance (rest/exercise, hyperoxia/hypercapnic hyperoxia) with repeated measures to point out the specific role of hypercapnia on cardiorespiratory parameters. In the ACZ study, a three-way analysis of variance with repeated measures was performed to evaluate the difference in period and peak power of $\dot{V}E$, SpO_2 , and $PETCO_2$ spectra between conditions (rest/exercise, normoxia/hypoxia, placebo/ACZ). A post hoc paired Student's test was then used when applicable. As exercise is associated with a concomitant variation in multiple variables, we performed a multivariate regression analysis in order to evaluate the independent influence of each cardiorespiratory variable on period and peak power of $\dot{V}E$, SpO_2 , and $PETCO_2$ spectra. This approach, for example, will allow us to assess the specific influence of $\dot{V}E$ and/or $\dot{Q}c$ on peak power and period of $\dot{V}E$.

Results

Values of measured cardiorespiratory variables are presented in Table 2.

Effect of hyperoxia

Effect of exercise versus rest

In the two-way ANOVA, $\dot{V}E$ and $PETCO_2$ increased with exercise ($P < 0.001$), SpO_2 being unchanged (Fig. 3). $\dot{V}E$ period was shorter ($P < 0.001$) and its peak power higher ($P < 0.001$). $PETCO_2$ period decreased ($P < 0.001$) and its peak power increased ($P < 0.05$). SpO_2 period was shorter ($P < 0.001$).

Table 2. Mean values of cardiorespiratory parameters for the hyperoxia (Hox), hypercapnic hyperoxia (Hox Hcap), and acetazolamide (ACZ) studies.

	$\dot{V}E(L \cdot min^{-1})$		SpO_2 (%)		$PETCO_2$ (mmHg)		$\dot{Q}c(L \cdot min^{-1})$		Ti (sec)		Ttot (sec)		VT (L)		HCVR ($L \cdot min^{-1} \cdot mmHg^{-1}$)
	Rest	Exer.	Rest	Exer.	Rest	Exer.	Rest	Exer.	Rest	Exer.	Rest	Exer.	Rest	Exer.	
Study Hox															
Nx	11.4 ± 1.9	33.9 ± 4.2 ^{###}	96.2 ± 1.2	96.0 ± 1.4	38.7 ± 1.7	45.8 ± 2.3	10.33 ± 1.81 ^{###}	5.53 ± 1.07	1.84 ± 0.62	1.40 ± 0.43	5.04 ± 1.56	3.16 ± 0.92 ^{##}	0.92 ± 0.20	1.74 ± 0.41 ^{###}	2.78 ± 0.86
Hox	12.5 ± 2.5	32.9 ± 4.7 ^{###}	98.0 ± 0.8 ^{###}	98.0 ± 0.7 ^{###}	36.8 ± 2.1 ^{###}	45.4 ± 3.4 ^{###}	9.78 ± 1.42 ^{###}	5.34 ± 0.79	1.42 ± 0.37 ^{###}	1.34 ± 0.44	4.75 ± 1.65	3.28 ± 0.94 ^{###}	0.93 ± 0.21	1.73 ± 0.34 ^{###}	
Study Hox Hcap															
Nx	11.9 ± 2.0	34.2 ± 5.6 ^{###}	96.6 ± 1.4	96.3 ± 1.6 [#]	38.9 ± 2.2	45.7 ± 2.7 ^{###}	10.22 ± 1.47 ^{###}	5.66 ± 1.14	1.75 ± 0.51	1.39 ± 0.43 ^{##}	4.65 ± 1.38	3.08 ± 0.95 ^{###}	0.90 ± 0.24	1.70 ± 0.38 ^{###}	
Hox Hcap	35.5 ± 8.5 ^{###}	72.9 ± 13.9 ^{###}	97.9 ± 0.5 ^{###}	97.9 ± 0.5 ^{###}	55.4 ± 2.7 ^{###}	66.3 ± 3.4 ^{###}	10.76 ± 1.62 ^{###}	5.25 ± 0.93	1.37 ± 0.29 ^{###}	1.04 ± 0.23 ^{###}	3.36 ± 0.79 ^{###}	2.29 ± 0.50 ^{###}	1.91 ± 0.42 ^{###}	2.59 ± 0.37 ^{###}	
Study ACZ															
Placebo															
Nx	11.6 ± 1.2	31.5 ± 4.4 ^{###}	96.3 ± 1.6	96.1 ± 1.3	40.5 ± 3.1	46.9 ± 3.1 ^{###}	11.19 ± 1.60 ^{###}	6.18 ± 1.06	1.88 ± 0.81	1.54 ± 0.54 [#]	4.58 ± 1.54	3.34 ± 0.95 ^{###}	0.87 ± 0.28	1.71 ± 0.38 ^{###}	2.46 ± 0.53
Hx	12.3 ± 1.5	33.9 ± 4.2 ^{###}	91.8 ± 1.9 ^{###}	88.8 ± 1.5 ^{###}	40.2 ± 2.9	44.8 ± 1.8 ^{###}	12.45 ± 2.35 ^{###}	6.93 ± 1.17 [#]	1.77 ± 0.61	1.46 ± 0.53	4.23 ± 1.07	3.12 ± 0.90 ^{###}	0.85 ± 0.21	1.72 ± 0.38 ^{###}	
ACZ															
Nx	12.3 ± 1.8	35.3 ± 4.7 ^{###}	96.3 ± 1.4	96.0 ± 1.1	34.4 ± 3.5 ^{###}	40.3 ± 4.6 ^{###}	12.45 ± 2.35 ^{###}	6.93 ± 1.17	1.88 ± 0.61	1.46 ± 0.53 [#]	4.73 ± 2.20	3.19 ± 0.91 ^{###}	0.93 ± 0.30	1.82 ± 0.41 ^{###}	3.78 ± 1.67 ^{###}
Hx	12.8 ± 1.5	36.3 ± 5.5 ^{###}	92.5 ± 1.3 ^{###}	88.3 ± 2.5 ^{###}	34.1 ± 3.8 ^{###}	37.9 ± 4.5 ^{###}	12.08 ± 2.36 ^{###}	6.52 ± 1.42 ^{###}	1.89 ± 0.86	1.42 ± 0.44 ^{###}	4.64 ± 1.58	3.19 ± 0.82 ^{###}	0.96 ± 0.27	1.87 ± 0.34 ^{###}	

Nx, normoxia; Hx, hypoxia; Exer., Exercise; $\dot{V}E$, minute ventilation; SpO_2 , pulse O_2 saturation; $PETCO_2$, end-tidal P_{CO_2} ; $\dot{Q}c$, cardiac output; Ti, inspiration time; Ttot, total respiration cycle time; VT, tidal volume; HCVR, hypercapnic ventilatory response. Mean ± SD. Exercise versus Rest: # $P < 0.05$; ## $P < 0.01$; ### $P < 0.001$. Hypercapnic hyperoxia or hypoxia versus normoxia: # $P < 0.05$; ## $P < 0.01$; ### $P < 0.001$. Hypercapnic hyperoxia versus hyperoxia: * $P < 0.05$; ** $P < 0.01$; *** $P < 0.001$. ACZ versus placebo: # $P < 0.05$; * $P < 0.01$; ** $P < 0.001$.

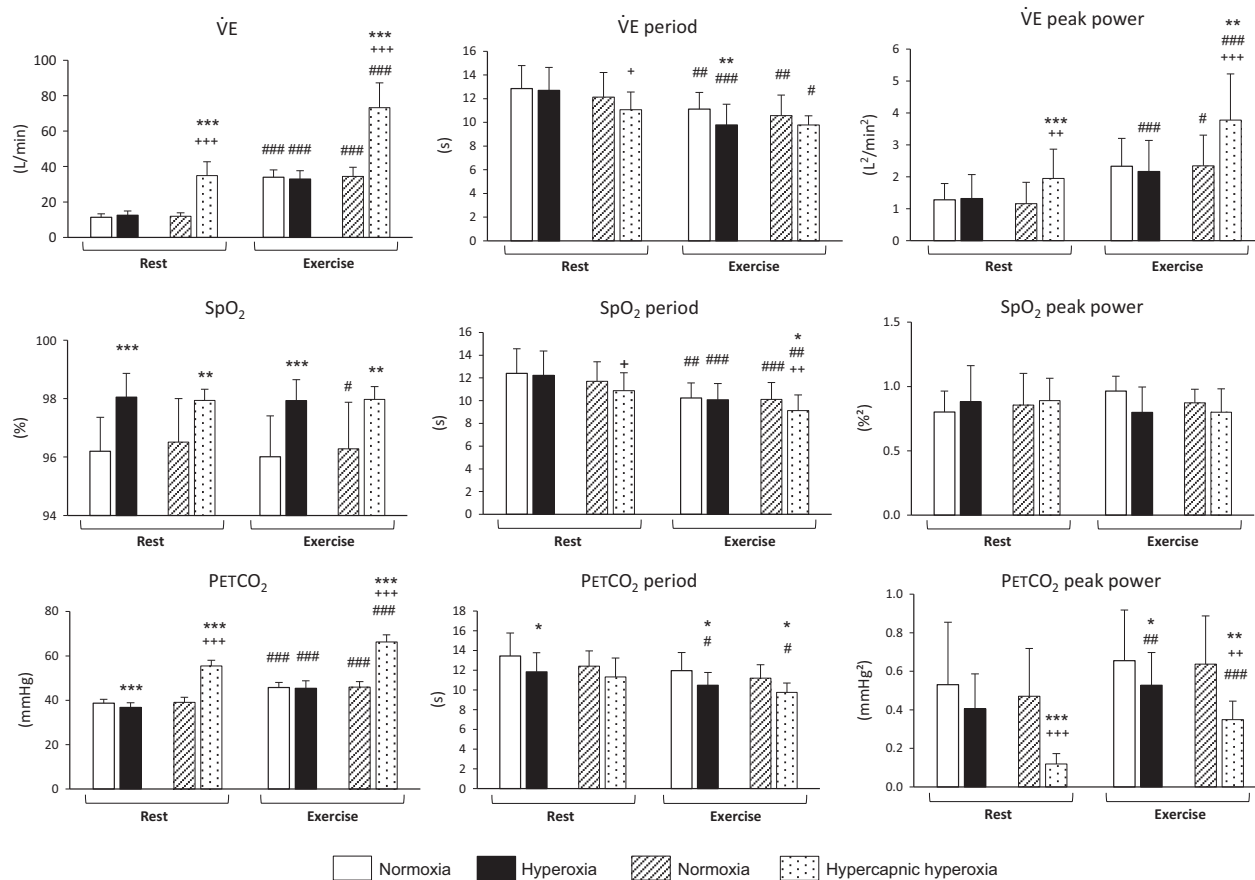

Figure 3. Mean (\pm SD) values of $\dot{V}E$, SpO_2 , and $PETCO_2$ and corresponding periods and peak powers in normoxia, hyperoxia, and hypercapnic hyperoxia. Exercise versus Rest: # $P < 0.05$; ## $P < 0.01$; ### $P < 0.001$. Hypercapnic hyperoxia or hyperoxia versus normoxia: * $P < 0.05$; ** $P < 0.01$; *** $P < 0.001$. Hypercapnic hyperoxia versus hyperoxia: + $P < 0.05$, ++ $P < 0.01$, +++ $P < 0.001$.

Effect of hyperoxia versus normoxia

In the two-way ANOVA, $\dot{V}E$ was not different in hyperoxia, whereas SpO_2 increased ($P < 0.001$) and $PETCO_2$ decreased ($P < 0.05$). $\dot{V}E$ period tended to be slightly shorter ($P = 0.07$), as well as $PETCO_2$ period. $PETCO_2$ peak power decreased ($P < 0.01$).

The post hoc analysis showed that, at exercise, $\dot{V}E$ and $PETCO_2$ periods were shorter in hyperoxia (vs. normoxia, $P < 0.01$). $\dot{V}E$ peak power remained unchanged, whereas $PETCO_2$ peak power decreased significantly ($P < 0.05$).

Effect of hypercapnic hyperoxia

Effect of exercise versus rest

In the two-way ANOVA, $\dot{V}E$ and $PETCO_2$ increased with exercise ($P < 0.001$) (Fig. 3). $\dot{V}E$ and $PETCO_2$ periods were shorter ($P < 0.01$ and $P < 0.001$, respectively) and their peak power greater ($P < 0.001$).

Effect of hypercapnic hyperoxia versus normoxia

In the two-way ANOVA, $\dot{V}E$, SpO_2 , and $PETCO_2$ increased ($P < 0.001$) in hypercapnic hyperoxia. $\dot{V}E$ period was shorter and its peak power was greater ($P < 0.05$ and $P < 0.001$, respectively). $PETCO_2$ period was shorter ($P < 0.01$) and its peak power was smaller ($P < 0.001$).

The post hoc analysis showed that, at exercise, SpO_2 and $PETCO_2$ periods decreased in hypercapnic hyperoxia (vs. normoxia, $P < 0.05$). $\dot{V}E$ peak power was greater (vs. normoxia, $P < 0.01$), whereas $PETCO_2$ peak power was lower (vs. normoxia, $P < 0.01$).

Effect of hypercapnia: hypercapnic hyperoxia versus hyperoxia

A two-way ANOVA evidenced an increase in $\dot{V}E$ and $PETCO_2$ in hypercapnic hyperoxia (vs. hyperoxia, $P < 0.001$) (Fig. 3). As expected, SpO_2 was not significantly

different between conditions. The period of ventilatory oscillations tended to be shorter in hypercapnic hyperoxia (vs. hyperoxia, $P = 0.054$). $\dot{V}E$ peak power was greater in hypercapnic hyperoxia (vs. hyperoxia, $P < 0.001$). $PETCO_2$ period was not modified by hypercapnia, whereas $PETCO_2$ peak power decreased ($P < 0.001$).

Effect of ACZ

One subject had to stop the experimentation due to side effects of ACZ administration (headaches, nausea), so that 12 subjects performed the experiment (Fig. 4).

Typical complete breath-by-breath recordings in hypoxia under placebo (upper panel) and ACZ (lower panel) are presented in Fig. 1. Oscillations of $\dot{V}E$ during exercise are clearly less noticeable under ACZ condition, which is confirmed by a lower peak power in the corresponding frequency spectrum of the ventilation signal (Fig. 2, right).

Effect of exercise versus rest

During exercise, $\dot{V}E$ and $PETCO_2$ increased ($P < 0.001$) and SpO_2 decreased ($P < 0.001$). $\dot{V}E$, SpO_2 and $PETCO_2$ periods were shorter ($P < 0.001$). $\dot{V}E$ and $PETCO_2$ peak powers were higher ($P < 0.001$ and $P < 0.01$, respectively).

Effect of hypoxia versus normoxia

In hypoxia, SpO_2 and $PETCO_2$ were lower ($P < 0.001$ and $P < 0.01$, respectively), and $\dot{V}E$ tended to be higher ($P = 0.053$). $\dot{V}E$, SpO_2 , and $PETCO_2$ periods were not significantly different, whereas $\dot{V}E$ and $PETCO_2$ peak power increased ($P < 0.001$ and $P < 0.01$, respectively).

Effect of ACZ versus placebo

ACZ increased $\dot{V}E$ ($P < 0.01$) and lowered $PETCO_2$ ($P < 0.001$). As expected, SpO_2 did not change in normoxia.

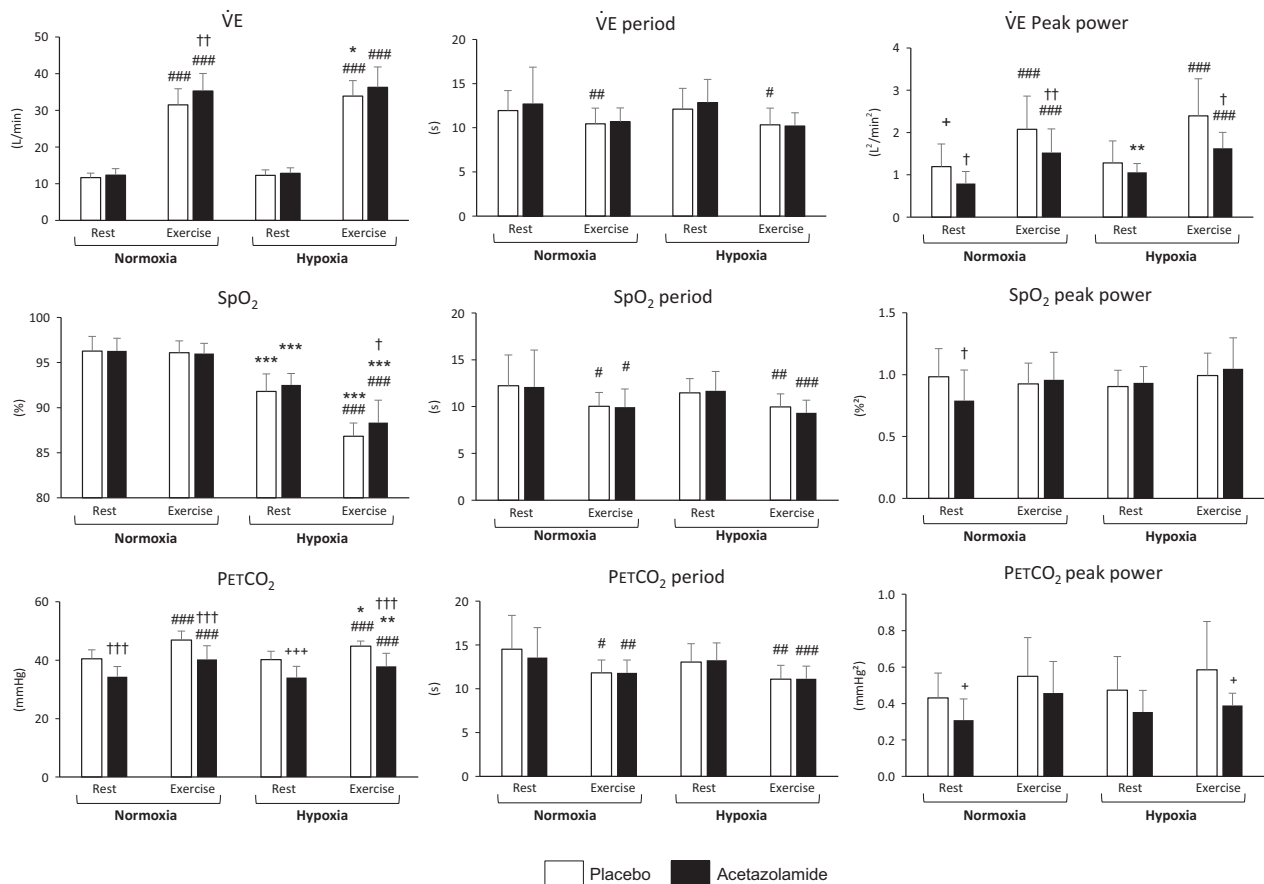

Figure 4. Mean (\pm SD) values of $\dot{V}E$, SpO_2 , and $PETCO_2$ and corresponding periods and peak powers in normoxia (Nx) and hypoxia (Hx), under placebo or acetazolamide treatment. Exercise versus Rest: # $P < 0.05$; ## $P < 0.01$; ### $P < 0.001$. Hypoxia versus normoxia: * $P < 0.05$; ** $P < 0.01$; *** $P < 0.001$. Acetazolamide versus placebo: † $P < 0.05$, †† $P < 0.01$, ††† $P < 0.001$.

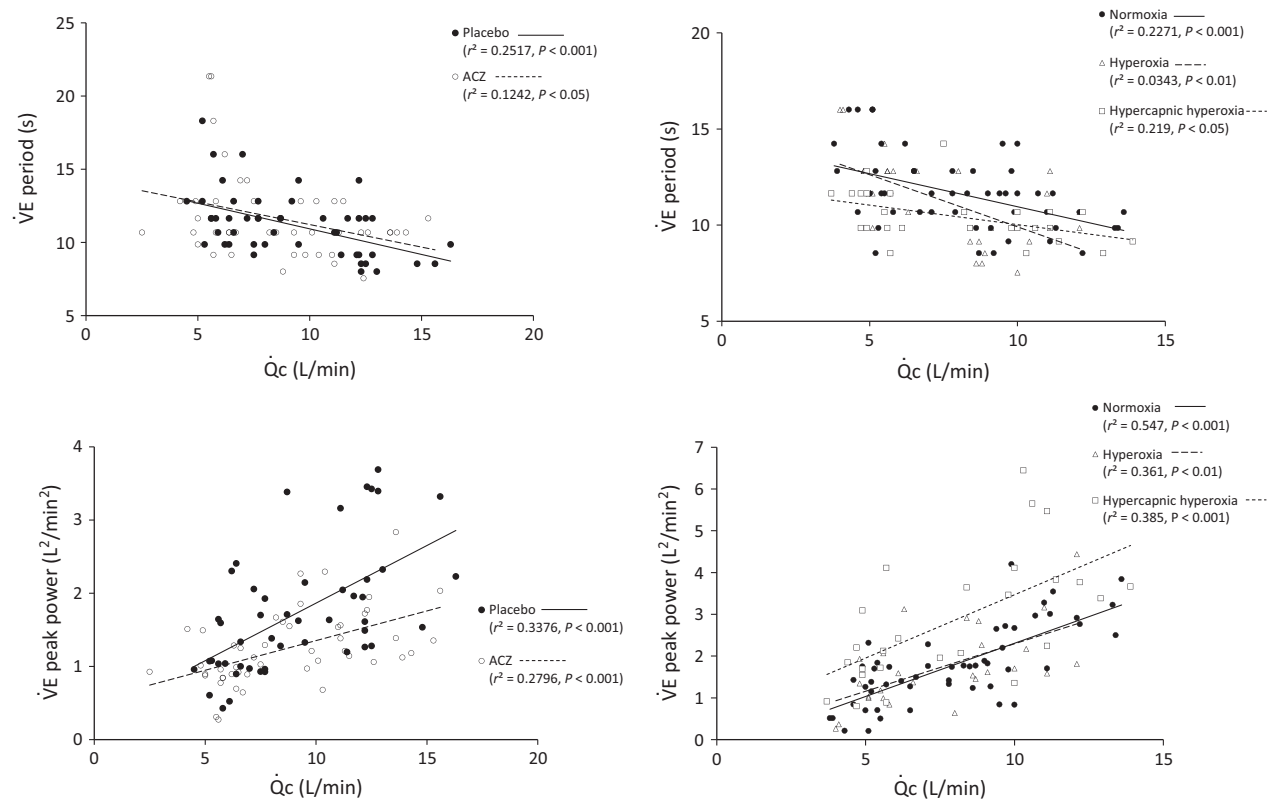

Figure 5. Ventilation period (upper panels) and peak power (lower panels) as a function of cardiac output (\dot{Q}_c). Left panels: ACZ and placebo. Right panels: normoxia, hyperoxia, and hypercapnic hyperoxia. Rest and exercise values have been pooled in all conditions. Normoxia and hypoxia values have been pooled in the ACZ versus placebo study. Slopes are significantly different between placebo and ACZ for the $\dot{V}E$ peak power versus \dot{Q}_c correlation ($P < 0.05$).

When considering only hypoxic condition, ACZ increased SpO_2 ($P < 0.05$). $\dot{V}E$, SpO_2 , and $PETCO_2$ periods were not modified. $\dot{V}E$ and $PETCO_2$ peak powers were lower under ACZ ($P < 0.001$). For all subjects, the average period was around 12.4 sec at rest and significantly decreased to 10.4 sec at exercise ($P < 0.001$), without any difference between the placebo and the ACZ groups.

Cardiorespiratory variables affecting $\dot{V}E$ period and $\dot{V}E$ peak power

In a first univariate approach, regressions for $\dot{V}E$ period and $\dot{V}E$ peak power, for each condition (normoxia, hyperoxia, hypercapnic hyperoxia, placebo, and ACZ), with \dot{Q}_c or $\dot{V}E$ were assessed (Figs. 5 and 6, respectively). In all conditions, $\dot{V}E$ period was negatively related to $\dot{V}E$ and \dot{Q}_c (upper panels), whereas $\dot{V}E$ peak power was positively correlated with $\dot{V}E$ and \dot{Q}_c (lower panels). It is noticeable that ACZ administration significantly decreased (vs. placebo) the slope of the regression between $\dot{V}E$ peak power and \dot{Q}_c as well as $\dot{V}E$ ($P < 0.05$):

the higher \dot{Q}_c or $\dot{V}E$, the greater the effect of ACZ (Figs. 5 and 6, lower left panels). In addition, for a given level of \dot{Q}_c , $\dot{V}E$ peak power was always higher in hypercapnia, the regression slopes being similar (Fig. 5, lower right panel). HCVR was higher under ACZ (vs. placebo, $P < 0.01$, Table 2). However, there was no significant correlation between HCVR and the corresponding $\dot{V}E$ peak power, under placebo and ACZ (Fig. 7), nor between HCVR placebo-ACZ difference and the corresponding $\dot{V}E$ peak power placebo-ACZ difference ($P = 0.18$). Although the linear relationship between $\dot{V}E$ peak power and HCVR did not reach significance, Fig. 7 clearly shows that for a given level of HCVR, ACZ decreases $\dot{V}E$ peak power.

As several variables, such as \dot{Q}_c , $\dot{V}E$ and T_{tot} , may vary simultaneously in response to exercise or environmental constraints, we performed a multivariate regression analysis to assess the specific role of each of these variables on ventilatory oscillations. When pooling all values obtained at rest and exercise, this analysis evidenced T_{tot} as the most significant factor explaining changes in $\dot{V}E$ period ($P < 0.001$),

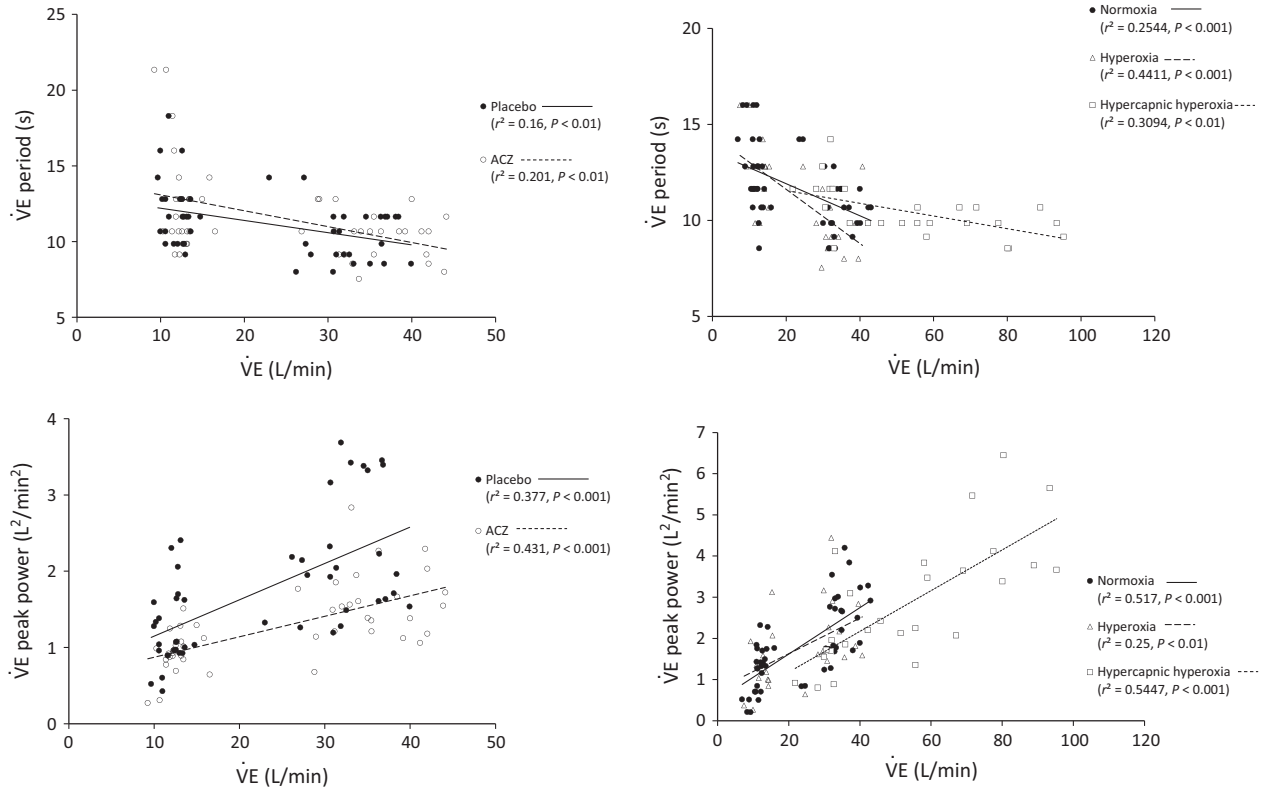

Figure 6. Ventilation period (upper panels) and peak power (lower panels) as a function of ventilation ($\dot{V}E$). Left panels: ACZ and placebo. Right panels: normoxia, hyperoxia, and hypercapnic hyperoxia. Rest and exercise values have been pooled in all conditions. Normoxia and hypoxia values have been pooled in the ACZ versus placebo study. Slopes are significantly different between placebo and ACZ for the $\dot{V}E$ peak power versus $\dot{Q}c$ correlation ($P < 0.05$).

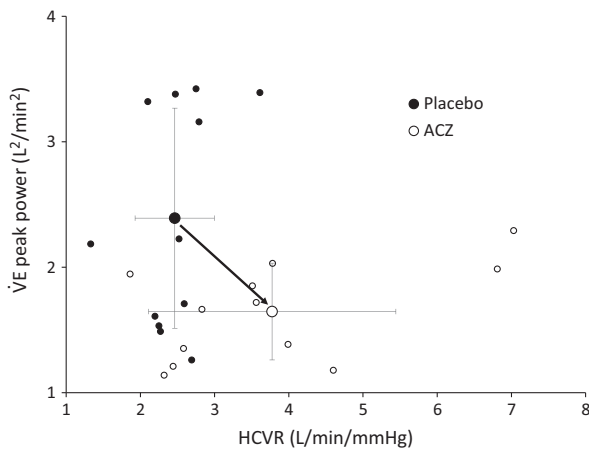

Figure 7. $\dot{V}E$ peak power as a function of HCVR for each subject under placebo and ACZ (large symbols: mean values \pm SD, black dot, Placebo; white dot, ACZ). ACZ increases HCVR and reduces $\dot{V}E$ peak power, but these relationships do not reach significance (Placebo: $r^2 = 0.123$, $P = 0.26$; ACZ: $r^2 = 0.273$, $P = 0.08$). However, it is clear that ACZ blunts the effect of HCVR on ventilatory oscillations (arrow).

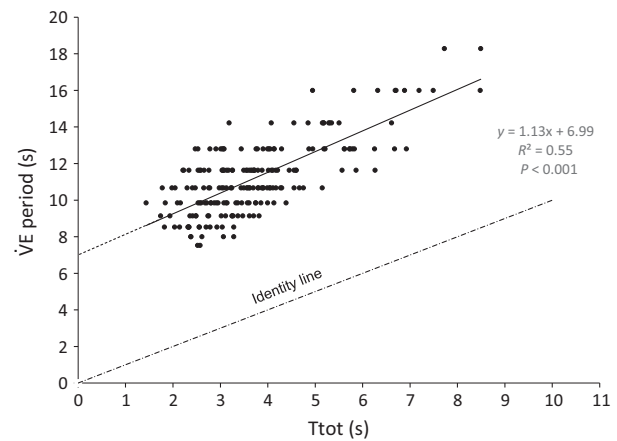

Figure 8. Linear regressions between $\dot{V}E$ period and total respiratory cycle time (Ttot) in the ACZ study. All values (rest/exercise, normoxia/hypoxia, placebo/ACZ) have been pooled.

as illustrated in Fig. 8. Concerning $\dot{V}E$ peak power, $\dot{V}E$ ($P < 0.001$) and Ttot ($P < 0.02$), but not $\dot{Q}c$ ($P = 0.094$), were found as explaining variables.

To summarize the main results of these three studies:

- 1 Hyperoxia reduced the period of $\dot{V}E$ and $PETCO_2$ oscillations and decreased $PETCO_2$ peak power at exercise.
- 2 Hypercapnia increased $\dot{V}E$ peak power and decreased $\dot{V}E$ period, whereas it reduced the amplitude of $PETCO_2$ oscillations.
- 3 ACZ blunted $\dot{V}E$ and $PETCO_2$ oscillations but did not alter corresponding periods.
- 4 Exercise increased amplitudes and shortened periods of $\dot{V}E$ and $PETCO_2$ oscillations in all conditions.

Discussion

To our knowledge, this is the first study on ventilatory oscillations performed on healthy subjects under physiological (exercise) and environmental stress (hypoxia/hyperoxia/hypercapnia) and under pharmacological challenge (ACZ). Our previous work evidenced for the first time ventilatory oscillations in hypoxia at exercise in normal subjects, and the importance of peripheral chemoreceptors in their genesis (Hermand et al. 2015). This study reveals further factors that may modulate these oscillations and proposes some mechanistic hypotheses. Hyperoxia, which silences peripheral chemoreceptors (Sinski et al. 2014), did not modify $\dot{V}E$ peak power and therefore $\dot{V}E$ oscillations in healthy subjects, in accordance with some but not all studies in patients with mixed sleep apnea (Brack et al. 2012). We evidenced a very significant increase in $\dot{V}E$ peak power in hypercapnia, conversely to what was found in central and obstructive apneas, where CO_2 inhalation drastically reduced ventilatory oscillations (Hudgel et al. 1988; Brack et al. 2012). The effect of ACZ treatment in healthy subjects in hypoxia at exercise was similar to what was observed in subjects at high altitude (Ainslie et al. 2013) and CSR-OA patients (Lalande et al. 2009; Brack et al. 2012): average minute ventilation was augmented and $PETCO_2$ decreased, whereas ventilatory oscillations were considerably reduced at exercise in hypoxia. This confirms the blunting of loop gain by ACZ observed in OSA patients (Edwards et al. 2012). It has been reported that ACZ could impair respiratory muscle and therefore modify the breathing pattern during exercise (Gonzales and Scheuermann 2013). However, a much lower dose of ACZ was used in this study and exercise intensity was limited to 30% of MAP. Moreover, as VT and Ti were not modified by ACZ in rest or exercise conditions (Table 2), we therefore assume that ACZ did not impact breathing pattern.

Mechanisms

These results provide new insights on mechanisms involved in ventilatory oscillations in healthy subjects (Fig. 9). The activity of the respiratory central pattern generator could be modulated by an oscillator, the activity of which would depend on various chemical stimuli. This oscillator would promote the instability of the system. Given that this instability seems to be directly related to the intensity of $\dot{V}E$ and $\dot{Q}c$, it is not surprising to observe the destabilizing effect of exercise, hypoxia and hypercapnia, which are known to increase $\dot{V}E$ and $\dot{Q}c$. ACZ has contrasting effects: it inhibits the effect of hypoxia (Ainslie et al. 2013) and enhances the effect of hypercapnia on ventilation (Vovk et al. 2000). In this study, ACZ also blunts the relation between ventilatory oscillations and $\dot{V}E$ or $\dot{Q}c$ (Figs. 5 and 9). Hyperoxia deactivates peripheral chemoreceptors (Sinski et al. 2014), and, to our knowledge, has no action on central chemoreceptors in humans. Although hyperoxia did not significantly decrease $\dot{V}E$ peak power, as we could expect regarding the inhibition of peripheral chemoreceptors, there is a tendency for a decrease in $\dot{V}E$ and SpO_2 peak power at exercise and a significant decrease in $PETCO_2$ peak power. Therefore, the hyperoxia-induced inhibition of carotid bodies would not be strong enough, alone, to modulate ventilatory oscillations.

CO_2 stimulates central chemoreceptors, but is also, in a lesser extent, a determinant factor in peripheral chemoreflex

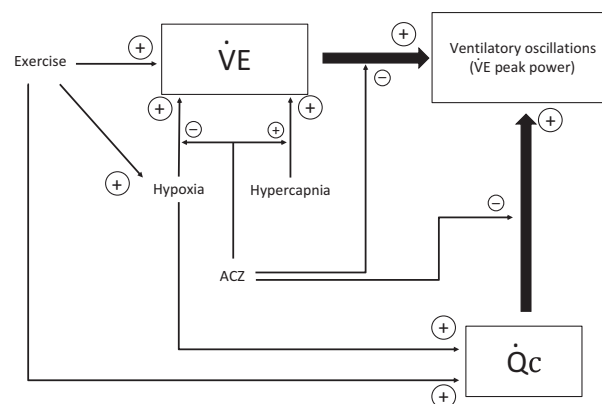

Figure 9. Schematic diagram of potential mechanisms involved in the genesis of ventilatory oscillations in normal subjects at exercise. Breathing instability is directly related to the intensity of $\dot{V}E$ and $\dot{Q}c$. Exercise, hypoxia and hypercapnia increase $\dot{V}E$ and $\dot{Q}c$, and therefore increase ventilatory oscillations. ACZ inhibits the effect of hypoxia and enhances the effect of hypercapnia on ventilation, and blunts the relation between $\dot{V}E$ or $\dot{Q}c$, and ventilatory oscillations. The complex effects of ACZ on this regulation system are still debated (see discussion).

activation in hypoxia (Mohan and Duffin 1997). Therefore, the noticeable increase in ventilatory oscillations in hypercapnia could be mainly attributed to the activation of central chemoreceptors, without completely ruling out a potential peripheral involvement of CO₂ in hyperoxia.

Acetazolamide stimulates central chemoreceptors but reduces peripheral chemoreceptors activity (Ainslie et al. 2013). However, its mechanisms of action have been extensively debated (Teppema 2014). Putting the decrease in ventilatory oscillations under ACZ in perspective with the increase in these oscillations in hypoxia when peripheral chemoreceptors are stimulated, confirms that peripheral chemoreceptors play a key role in the genesis of ventilatory oscillations. It validates the hypothesis we put forward in our preliminary study showing that oscillations are enhanced in subjects with high HVR (Hermand et al. 2015). However, ventilatory oscillations are also greater under a hyperoxic hypercapnic stress, when peripheral chemoreceptors are silenced, thus implying that central chemoreceptors are also a major actor of breathing instability. This suggests that ventilatory oscillations depend on a subtle and synergic action of both central and peripheral chemoreceptors, through arterial O₂ and CO₂ pressure.

Moreover, we observed that, in hypercapnic hyperoxia, PETCO₂ and $\dot{V}E$ exhibited dichotomous oscillations properties: PETCO₂ peak power was paradoxically lower in hypercapnia whereas $\dot{V}E$ peak power was higher. CO₂ stores being close to saturation in hypercapnia, despite a higher ventilation to flush it out, the measured expired CO₂ level is then not subjected to oscillations as observed for $\dot{V}E$, as a full CO₂ store will damp systemic CO₂ variations.

ACZ augments the controller gain (HCVR) but blunts the enhancing effects of controller gain on ventilatory oscillations (Fig. 7). This paradoxical effect of ACZ, reducing ventilatory oscillations (i.e., loop gain) in spite of the rise of controller gain, means a very significant reduction of plant gain, evoked in Javaheri's work (Javaheri et al. 2014). While we were not able to determine the value of the plant gain, we nevertheless observed a noticeable decrease in PETCO₂ under ACZ in all conditions (Fig. 4), therefore inducing a lower CO₂ reserve and a lower plant gain (White 2005; Javaheri et al. 2014).

Mechanisms leading to reduced ventilatory oscillations under ACZ are still debated. This may involve a third arm, the mixing gain, depending, among other factors, on cerebral blood flow which might increase the CO₂ wash-out of the cerebral spinal fluid and therefore blunt ventilatory oscillations (Younes et al. 2001; Dempsey et al. 2004; Skow et al. 2014). However, both exercise (Ogoh and Ainslie 2009) and ACZ (Okazawa et al. 2001) are

known to increase cerebral blood flow but have opposite effects on breathing instability (this study).

The multivariate analysis showing that the intensity of oscillations is related to $\dot{V}E$ and T_{tot}, but insignificantly to $\dot{Q}c$, gives a clue to the apparent contradiction between our observations of greater ventilatory oscillations with increasing $\dot{Q}c$ (Fig. 5) and the current hypothesis of low $\dot{Q}c$ induced periodic breathing in CHF patients (Agostoni 2008).

The tight relationship between $\dot{V}E$ period and T_{tot} observed in our previous work is confirmed (Fig. 8): $\dot{V}E$ period is strongly linked to the duration of the respiratory cycle, independently of other cardiorespiratory factors such as $\dot{V}E$ and $\dot{Q}c$. This suggests that T_{tot} is a determinant factor of the intrinsic oscillator. This correlation also pointed out a theoretical limit of $\dot{V}E$ oscillation period: when T_{tot} tends toward zero (breathing frequency tending to infinity), $\dot{V}E$ oscillation period tends to approximately 7 sec. This tight relationship between $\dot{V}E$ period and T_{tot} also suggests the involvement of an internal oscillator that would modulate the activity of the central pattern generator, responsible for the generation of respiratory rhythm in mammals (Forster et al. 2014).

In conclusion, these findings confirm the existence of a mechanism that modulates ventilation and induces breathing instability, especially during exercise in hypoxic and hypercapnic conditions. This instability, unraveled in healthy awake subjects after a brisk challenge, depends on a complex regulation system involving O₂ and CO₂ sensing where both peripheral (high HVR and effect of ACZ) and central (hypercapnia and tight relationship between period and T_{tot}) chemoreflex seem to play a key role. We expect this study to contribute to the knowledge of factors involved in sleep apneas of central and obstructive origins.

Conflict of Interest

None declared.

References

- Agostoni, P. 2008. Mechanisms of periodic breathing during exercise in patients with chronic heart failure. *CHEST J.* 133:197.
- Ainslie, P. N., S. J. E. Lucas, and K. R. Burgess. 2013. Breathing and sleep at high altitude. *Respir. Physiol. Neurobiol.* 188:233–256.
- Andreas, S., C. Clemens, H. Sandholzer, H. R. Figulla, and H. Kreuzer. 1996. Improvement of exercise capacity with treatment of Cheyne-Stokes respiration in patients with congestive heart failure. *J. Am. Coll. Cardiol.* 27:1486–1490.
- Andreas, S., K. Weidel, G. Hagenah, and S. Heindl. 1998. Treatment of Cheyne-Stokes respiration with nasal oxygen and carbon dioxide. *Eur. Respir. J.* 12:414–419.

- Apostolo, A., P. Agostoni, M. Contini, L. Antonioli, and E. R. Swenson. 2014. Acetazolamide and inhaled carbon dioxide reduce periodic breathing during exercise in patients with chronic heart failure. *J. Card. Fail.* doi:10.1016/j.cardfail.2014.01.007.
- Basner, R. C. 2011. Loop gain: can it help close the heart failure-periodic breathing loop? *Am. J. Respir. Crit. Care Med.* 184:996–997.
- Berssenbrugge, A., J. Dempsey, C. Iber, J. Skatrud, and P. Wilson. 1983. Mechanisms of hypoxia-induced periodic breathing during sleep in humans. *J. Physiol.* 343:507–524.
- Blain, G. M., C. A. Smith, K. S. Henderson, and J. A. Dempsey. 2010. Peripheral chemoreceptors determine the respiratory sensitivity of central chemoreceptors to CO₂: peripheral-central chemoreceptor interdependence. *J. Physiol.* 588:2455–2471.
- Bourdillon, N., J.-L. Fan, and B. Kayser. 2014. Cerebral oxygenation during the Richalet hypoxia sensitivity test and cycling time-trial performance in severe hypoxia. *Eur. J. Appl. Physiol.* 114:1037–1048.
- Brack, T., W. Randerath, and K. E. Bloch. 2012. Cheyne-Stokes respiration in patients with heart failure: prevalence, causes, consequences and treatments. *Respiration* 83:165–176.
- Burgess, K. R. 2012. New insights from the measurement of loop gain in obstructive sleep apnoea. *J. Physiol.* 590:1781–1782.
- Canouï-Poitrine, F., K. Veerabudun, P. Larmignat, M. Letournel, S. Bastuji-Garin, and J.-P. Richalet. 2014. Risk prediction score for severe high altitude illness: a cohort study. *PLoS ONE* 9:e100642.
- Charloux, A., E. Lonsdorfer-Wolf, R. Richard, E. Lampert, M. Oswald-Mammosser, B. Mettauer, et al. 2000. A new impedance cardiograph device for the non-invasive evaluation of cardiac output at rest and during exercise: comparison with the “direct” Fick method. *Eur. J. Appl. Physiol.* 82:313–320.
- Cherniack, N. S. 2005. Mathematical models of periodic breathing and their usefulness in understanding cardiovascular and respiratory disorders. *Exp. Physiol.* 91:295–305.
- Dempsey, J. A., C. A. Smith, T. Przybylowski, B. Chenuel, A. Xie, H. Nakayama, et al. 2004. The ventilatory responsiveness to CO₂ below eupnoea as a determinant of ventilatory stability in sleep. *J. Physiol.* 560:1–11.
- Dempsey, J. A., S. C. Veasey, B. J. Morgan, and C. P. O'Donnell. 2010. Pathophysiology of sleep apnea. *Physiol. Rev.* 90:47–112.
- Dhakal, B. P., R. M. Murphy, and G. D. Lewis. 2012. Exercise oscillatory ventilation in heart failure. *Trends Cardiovasc. Med.* 22:185–191.
- Duffin, J., and J. H. Mateika. 2013. Cross-Talk opposing view: peripheral and central chemoreflexes have additive effects on ventilation in humans. *J. Physiol.* 591:4351–4353.
- Edwards, B. A., S. A. Sands, D. J. Eckert, D. P. White, J. P. Butler, R. L. Owens, et al. 2012. Acetazolamide improves loop gain but not the other physiological traits causing obstructive sleep apnoea. *J. Physiol.* 590:1199–1211.
- Fan, J.-L., K. R. Burgess, K. N. Thomas, S. J. E. Lucas, J. D. Cotter, B. Kayser, et al. 2012. Effects of acetazolamide on cerebrovascular function and breathing stability at 5,050 m. *J. Physiol.* 590:1213–1225.
- Fischer, R., S. M. Lang, M. Leitl, M. Thiere, U. Steiner, and R. M. Huber. 2004. Theophylline and acetazolamide reduce sleep-disordered breathing at high altitude. *Eur. Respir. J.* 23:47–52.
- Fontana, M., M. Emdin, A. Giannoni, G. Iudice, R. Baruah, and C. Passino. 2011. Effect of acetazolamide on chemosensitivity, Cheyne-Stokes respiration, and response to effort in patients with heart failure. *Am. J. Cardiol.* 107:1675–1680.
- Forster, H., J. Bonis, K. Krause, J. Wenninger, S. Neumueller, M. Hodges, et al. 2014. Contributions of the pre-Bötzinger complex and the Kölliker-fuse nuclei to respiratory rhythm and pattern generation in awake and sleeping goats. *Prog. Brain Res.* 209:73–89.
- Francis, D. P., K. Willson, L. C. Davies, A. J. Coats, and M. Piepoli. 2000. Quantitative general theory for periodic breathing in chronic heart failure and its clinical implications. *Circulation* 102:2214–2221.
- Franklin, K. A., P. Eriksson, C. Sahlin, and R. Lundgren. 1997. Reversal of central sleep apnea with oxygen. *Chest* 111:163–169.
- Garde, A., B. F. Giraldo, R. Jane, T. D. Latshang, A. J. Turk, T. Hess, et al. 2012. Periodic breathing during ascent to extreme altitude quantified by spectral analysis of the respiratory volume signal. *Conf. Proc. IEEE Eng. Med. Biol. Soc.* 2012:707–710.
- Giannoni, A., M. Emdin, F. Bramanti, G. Iudice, D. P. Francis, A. Barsotti, et al. 2009. Combined increased chemosensitivity to hypoxia and hypercapnia as a prognosticator in heart failure. *J. Am. Coll. Cardiol.* 53:1975–1980.
- Gold, A. R., E. R. Bleeker, and P. L. Smith. 1985. A shift from central and mixed sleep apnea to obstructive sleep apnea resulting from low-flow oxygen. *Am. Rev. Respir. Dis.* 132:220–223.
- Gonzales, J. U., and B. W. Scheuermann. 2013. Effect of acetazolamide on respiratory muscle fatigue in humans. *Respir. Physiol. Neurobiol.* 185:386–392.
- Hermand, E., A. Pichon, F. J. Lhuissier, and J.-P. Richalet. 2015. Periodic breathing in healthy humans at exercise in hypoxia. *J. Appl. Physiol.* 118:115–123.
- Hudgel, D. W., C. Hendricks, and A. Dudley. 1988. Alteration in obstructive apnea pattern induced by changes in oxygen- and carbon-dioxide-inspired concentrations. *Am. Rev. Respir. Dis.* 138:16–19.
- Javaheri, S., S. A. Sands, and B. A. Edwards. 2014. Acetazolamide attenuates hunter-cheyne-stokes breathing

- but augments the hypercapnic ventilatory response in patients with heart failure. *Ann. Am. Thorac. Soc.* 11:80–86.
- Kumar, P., and N. R. Prabhakar (2012). Peripheral chemoreceptors: function and plasticity of the carotid body in R. Terjung, ed. *Comprehensive physiology*. John Wiley & Sons, Inc., Hoboken, NJ, USA. Available at: <http://doi.wiley.com/10.1002/cphy.c100069> [Accessed March 31, 2014].
- Lahiri, S., and R. E. 2nd Forster. 2003. CO₂/H(+) sensing: peripheral and central chemoreception. *Int. J. Biochem. Cell Biol.* 35:1413–1435.
- Lahiri, S., A. Roy, S. M. Baby, T. Hoshi, G. L. Semenza, and N. R. Prabhakar. 2006. Oxygen sensing in the body. *Prog. Biophys. Mol. Biol.* 91:249–286.
- Lalande, S., E. M. Snyder, T. P. Olson, M. L. Hulsebus, M. Orban, V. K. Somers, et al. 2009. The effects of sildenafil and acetazolamide on breathing efficiency and ventilatory control during hypoxic exercise. *Eur. J. Appl. Physiol.* 106:509–515.
- Lhuissier, F. J., M. Brumm, D. Ramier, and J.-P. Richalet. 2012. Ventilatory and cardiac responses to hypoxia at submaximal exercise are independent of altitude and exercise intensity. *J. Appl. Physiol.* 112:566–570.
- Lorenzi-Filho, G., F. Rankin, I. Bies, and T. Douglas Bradley. 1999. Effects of inhaled carbon dioxide and oxygen on cheyne-stokes respiration in patients with heart failure. *Am. J. Respir. Crit. Care Med.* 159:1490–1498.
- Maestri, R., C. Bruschi, F. Olmetti, M. T. La Rovere, and G. D. Pinna. 2013. Assessment of the peripheral ventilatory response to CO₂ in heart failure patients: reliability of the single-breath test. *Physiol. Meas.* 34:1123–1132.
- McElroy, M. K., A. Gerard, F. L. Powell, G. K. Prisk, N. Sentse, S. Holverda, et al. 2000. Nocturnal O₂ enrichment of room air at high altitude increases daytime O₂ saturation without changing control of ventilation. *High Alt. Med. Biol.* 1:197–206.
- Mohan, R., and J. Duffin. 1997. The effect of hypoxia on the ventilatory response to carbon dioxide in man. *Respir. Physiol.* 108:101–115.
- Moraga, F. A., D. Jiménez, J. P. Richalet, M. Vargas, and J. Osorio. 2014. Periodic breathing and oxygen supplementation in Chilean miners at high altitude (4200 m). *Respir. Physiol. Neurobiol.* 203:109–115.
- Ogoh, S., and P. N. Ainslie. 2009. Cerebral blood flow during exercise: mechanisms of regulation. *J. Appl. Physiol.* 107:1370–1380.
- Okazawa, H., H. Yamauchi, K. Sugimoto, H. Toyoda, Y. Kishibe, and M. Takahashi. 2001. Effects of acetazolamide on cerebral blood flow, blood volume, and oxygen metabolism: a positron emission tomography study with healthy volunteers. *J. Cereb. Blood Flow Metab.* 21:1472–1479.
- Pinna, G. D., R. Maestri, A. Mortara, and M. T. La Rovere. 2000. Cardiorespiratory interactions during periodic breathing in awake chronic heart failure patients. *Am. J. Physiol. Heart Circ. Physiol.* 278:H932–H941.
- Ponikowski, P., S. D. Anker, T. P. Chua, D. Francis, W. Banasiak, P. A. Poole-Wilson, et al. 1999. Oscillatory breathing patterns during wakefulness in patients with chronic heart failure: clinical implications and role of augmented peripheral chemosensitivity. *Circulation* 100:2418–2424.
- Read, D. J. 1967. A clinical method for assessing the ventilatory response to carbon dioxide. *Australas Ann. Med.* 16:20–32.
- Richalet, J.-P., M. Rivera, P. Bouchet, E. Chirinos, I. Onnen, O. Petitjean, et al. 2005. Acetazolamide: a treatment for chronic mountain sickness. *Am. J. Respir. Crit. Care Med.* 172:1427–1433.
- Richalet, J.-P., P. Larmignat, E. Poitrine, M. Letournel, and F. Canoui-Poitrine. 2012. Physiological risk factors for severe high-altitude illness: a prospective cohort study. *Am. J. Respir. Crit. Care Med.* 185:192–198.
- Richard, R., E. Lonsdorfer-Wolf, A. Charloux, S. Doutreleau, M. Buchheit, M. Oswald-Mammosser, et al. 2001. Non-invasive cardiac output evaluation during a maximal progressive exercise test, using a new impedance cardiograph device. *Eur. J. Appl. Physiol.* 85:202–207.
- Rivera-Ch, M., L. Huicho, P. Bouchet, J. P. Richalet, and F. León-Velarde. 2008. Effect of acetazolamide on ventilatory response in subjects with chronic mountain sickness. *Respir. Physiol. Neurobiol.* 162:184–189.
- Sinski, M., J. Lewandowski, J. Przybylski, P. Zalewski, B. Symonides, P. Abramczyk, et al. 2014. Deactivation of carotid body chemoreceptors by hyperoxia decreases blood pressure in hypertensive patients. *Hypertens. Res.* 37:858–862.
- Skow, R. J., M. M. Tymko, C. M. MacKay, C. D. Steinback, and T. A. Day. 2014. The effects of head-up and head-down tilt on central respiratory chemoreflex loop gain tested by hyperoxic rebreathing. *Prog. Brain Res.* 212:149–172.
- Solin, P., T. Roebuck, D. P. Johns, E. H. Walters, and M. T. Naughton. 2000. Peripheral and central ventilatory responses in central sleep apnea with and without congestive heart failure. *Am. J. Respir. Crit. Care Med.* 162:2194–2200.
- Swenson, E. R. 1998. Carbonic anhydrase inhibitors and ventilation: a complex interplay of stimulation and suppression. *Eur. Respir. J.* 12:1242–1247.
- Swenson, E. R., K. L. Leatham, R. C. Roach, R. B. Schoene, W. J. Jr Mills, and P. H. Hackett. 1991. Renal carbonic anhydrase inhibition reduces high altitude sleep periodic breathing. *Respir. Physiol.* 86:333–343.
- Teppema, L. J. 2014. Multifaceted clinical effects of acetazolamide: will the underlying mechanisms please stand up? *J. Appl. Physiol.* 116:713–714.
- Vovk, A., J. Duffin, J. M. Kowalchuk, D. H. Paterson, and D. A. Cunningham. 2000. Changes in chemoreflex

- characteristics following acute carbonic anhydrase inhibition in humans at rest. *Exp. Physiol.* 85:847–856.
- Waggener, T. B., P. J. Brusil, R. E. Kronauer, R. A. Gabel, and G. F. Inbar. 1984. Strength and cycle time of high-altitude ventilatory patterns in unacclimatized humans. *J. Appl. Physiol.* 56:576–581.
- White, D. P. 2005. Pathogenesis of Obstructive and Central Sleep Apnea. *Am. J. Respir. Crit. Care Med.* 172:1363–1370.
- Younes, M., M. Ostrowski, W. Thompson, C. Leslie, and W. Shewchuk. 2001. Chemical control stability in patients with obstructive sleep apnea. *Am. J. Respir. Crit. Care Med.* 163:1181–1190.

Graphical Abstract

The contents of this page will be used as part of the graphical abstract of html only. It will not be published as part of main.

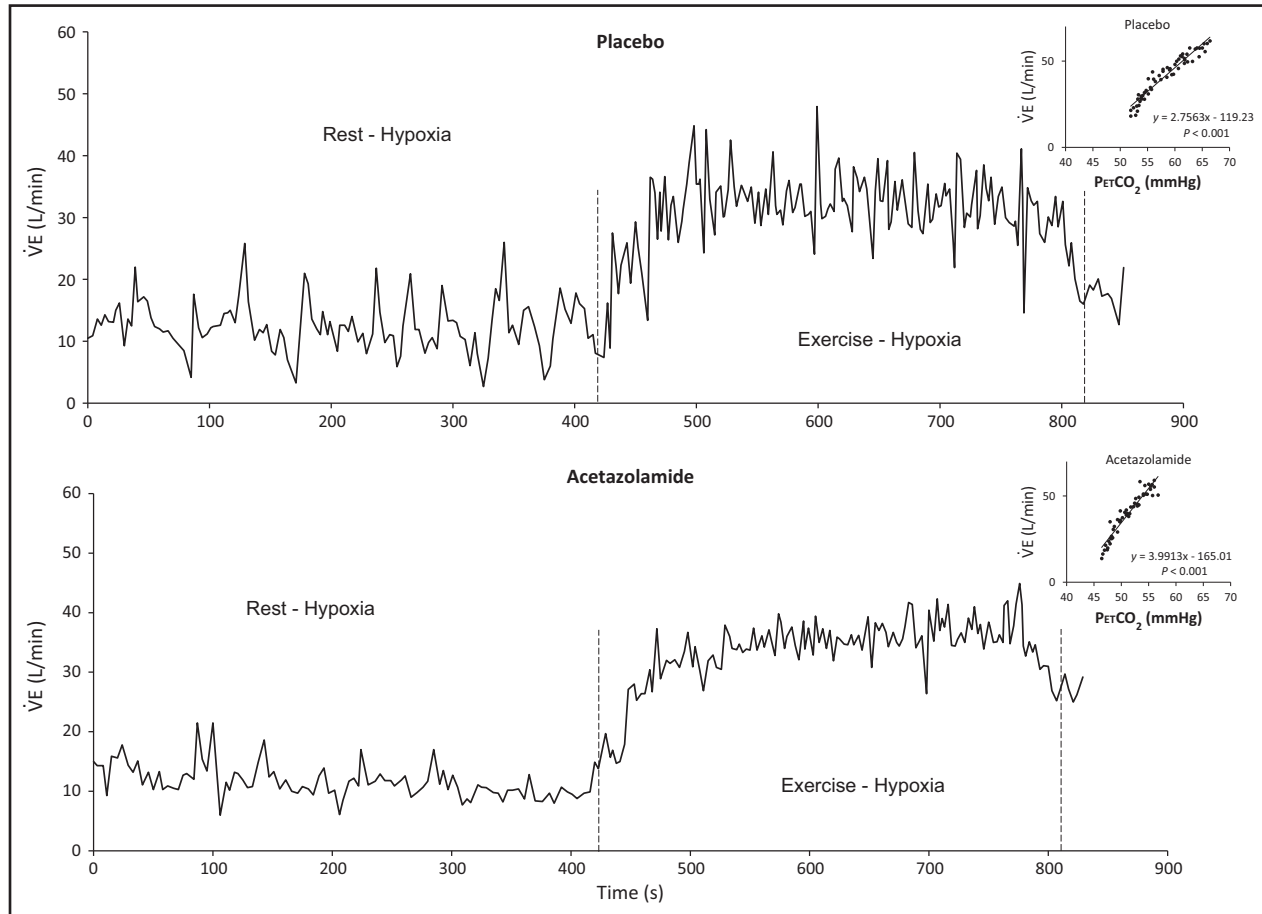

Combined hypoxia and exercise are two promoters of ventilatory instability. This study unravels other factors, which either amplify ventilatory oscillations (hypercapnia) or blunt them (acetazolamide, hyperoxia). These oscillations, shorter than those observed in heart failure or apnea syndrome, are associated with greater cardiac output and ventilation.